

The distribution of wealth and income in selected advanced countries – first comparative results for Japan

Markus Jäntti^{1,2}

¹Swedish Institute for Social Research, Stockholm University ²Luxembourg Income Study

LIS Japan Workshop
13 January

Introduction

- The KEIO dataset provides information on income, wealth, consumption, labor market status and demographics for households headed by 20-69 year old persons
- The LWS database is best fit for it
- This presentation will take a look at gross wealth and gross income in Japan compared to selected other countries

LWS Principles

- Built up within the Luxembourg Income Study (LIS) – www.lisproject.org following the same model.
- Establish a network of experts of micro-data on household net worth to share accumulated knowledge and best practices
- Construct a comparable database containing wealth variables based on existing datasets to enable cross-country comparisons on household net worth, portfolio composition and wealth distribution (including liquid assets, debts and other holdings)
- Produce guidelines for data producers – similar to what has been done for income distribution statistics through LIS with the final Report of the Canberra Group

LWS countries and datasets

Japan	Keio Household Panel Survey	2003
Austria	Survey of Household Financial Wealth	2004
Canada	Survey of Financial Security	1999
Cyprus	Survey of Consumer Finances	2002
Finland	Household Wealth Survey	1994, 1998
Germany	Socio-Economic Panel Study	2001, 2006
Italy	Survey of Household Income and Wealth	2002, 2004
Norway	Income and Wealth Survey	2002
Sweden	Wealth Survey	2002
United Kingdom	British Household Panel Study	2000
United States	Panel Study of Income Dynamics	2000
	Survey of Consumer Finances	2000-2006

Issues in LWS construction

Surveys differ:

- Purpose: some designed to collect wealth data (CA, IT, US-SCF), some supplemented with special modules (GE, UK, US-PSID)
- Source: mostly sample surveys, but supplemented with administrative data in Nordic countries
- Sampling frame: some over-sample the rich
- Unit of analysis: generally household, but individual in GE and UK, family in US and CA
- Number of wealth items: from 7 in UK to 30+ in IT, NW, US-SCF
- Perfect comparability cannot be achieved
- Define basic wealth concept

Ideal LWS variable structure

- Demographics
- Income and consumption aggregates
- Wealth variables -(household-individual-family level)
 - ▶
 - ▶ Non-financial assets
 - ▶ Financial Assets
 - ▶ Liabilities
- Behavioral variables
 - ▶
 - ▶ Bequest motivation
 - ▶ Inheritance expectations
 - ▶ Motives for savings
 - ▶ *Inter vivos* transfers
 - ▶ Risk attitude
 - ▶ Income and health uncertainty/risk
 - ▶ Expectations (fertility; income support from the state)

LWS Wealth Variables: Financial assets

Deposit Accounts: Transaction, Savings and CDs	DA
Total Bonds: Savings and Other Bonds	TB
Stocks	ST
Mutual Funds and other investment funds	TM
Life insurance	LI
Other investment./ financial assets(non-pen)	OFA
Pension Assets	PA

LWS Wealth Variables: Non-Financial assets

Principal residence	PR
Investment real estate	IR
Business Equity	BE
Vehicles	VH
Durables/Collectibles	DR/ CL
Other non-financial assets	ONF

LWS Wealth Variables: Liabilities

Total Liabilities	TD
Total Home secured debt	HSD
Principal residence mortgage	MG
Other property mortgage	OMG
Other home secured debt	OHSD
Vehicle loans	VL
Total Installment debt (inc. credit card bal)	IL
Educational loans	EL
Other loans from financial institutions	OL
Informal debt	ID

Wealth Summary Variables

Risky assets	$RA = TB + ST + TM$
Total assets	TA = sum of all assets
Home secured debt	$HSD = MG + OMG + OHSD$
Non-housing debt	$NHD = TD - HSD$
Total financial assets	$TFA1 = DA + ST + TB + TM$
Total non-financial assets	$TNF1 = PR + IR$
	$TNF2 = PR + IR + BA$
Total debt	$TD = HSD + VL + IL + EL + OL + ID$
Net worth	$NW1 = TFA1 + TNF1 - TD$
	$NW2 = TFA1 + TNF2 - TD$
	$NW = (\text{sum of all assets}) - (\text{sum of all debts})$

Other Wealth Variables

Miscellaneous net worth:	OWL
Inheritance received:	INH1-INH3
Year of inheritance:	YRINH1-YRINH3
Remaining inheritance:	INH4
Tenure:	OWN
Type of dwelling:	DWELL
Own business:	BUS
Special variables:	IRnet, Vhnet, Flags

Exploring the distribution of wealth and income

- introducing Japanese data on wealth and on income (2003)
- compare with
 - ▶ Canada 1999
 - ▶ Germany 2001
 - ▶ Sweden 2002
 - ▶ United Kingdom (UK) 2000
 - ▶ United States (US) 2000

Data definitions

- focus now on
 - ▶ *gross* wealth (not net worth = gross wealth – debt)
 - ▶ *gross* income (not on disposable income = gross income – direct taxes)
- household is the *sharing unit*
- individuals are the *unit of analysis*
- both wealth and income have been *equivalized*
- outlying observations can be very influential: also study “shaved” data (inner 98 percent of the marginal distributions of both income and wealth)

Analysis

- aspects of the distribution of wealth and its components
- distributional comparisons (“Pen’s parade”, cumulative distribution functions)
- Lorenz, Generalized Lorenz and Absolute Lorenz orderings of countries
- descriptive quantile regressions (10th, 50th [median] and 90th percentiles as functions of age, education of household head and household structure)
- examine the (conditional) joint distribution of income and wealth

Sample sizes and outliers

	Canada	Germany	Japan	Sweden	UK	US
Pre-shaving	13520	10909	5139	14355	7102	6680
Post-shaving	12477	8977	3475	11621	5012	5972
Difference	1043	1932	1664	2734	2090	708

Pre-shave percentiles

	Percentiles				
	1	10	50	90	99
Income					
Canada	1976	9835	28041	57891	115673
Germany	2316	10313	28131	59898	121111
Japan	3155	7302	19126	39438	54098
Sweden	3884	13380	27369	47353	87731
UK	1360	9261	23945	49401	94656
US	2393	11426	37040	91285	311850
Wealth					
Canada	262	4799	104975	381790	1190518
Germany	0	0	66768	341477	1124364
Japan	0	0	51843	239522	698841
Sweden	0	0	44816	179093	503063
UK	0	342	83779	271210	788358
US	0	1701	82673	414240	1800467

Proportion with positive wealth and debt

All and middle income classes

Proportion positive	Net worth	Fin. assets	Non-fin. assets	Debt
Canada				
all	95.2	95.5	100.0	80.6
Middle Income	98.4	99.2	100.0	86.5
Germany				
all	93.9	93.0	66.7	52.4
Middle Income	94.0	95.2	69.9	57.1
Japan				
all	88.1	85.5	70.5	45.6
Middle Income	89.3	87.7	72.7	49.6
Sweden				
all	76.9	94.2	77.0	88.2
Middle Income	79.9	95.4	83.8	90.7
UK				
all	90.9	86.1	93.5	80.6
Middle Income	94.1	91.9	97.3	87.3
US				
all	91.0	87.9	96.5	79.3
Middle Income	93.4	94.9	98.1	86.9



CROSS-NATIONAL
DATA CENTER
in Luxembourg

Mean wealth and debt

All and middle income classes

Average	Net worth	Fin. assets	Non-fin. assets	Debt
Canada				
all	98348	46272	72687	20611
Middle Income	103142	47970	79027	23856
Germany				
all	91280	24246	91726	24692
Middle Income	93503	23628	96428	26553
Japan				
all	63309	20352	61598	18641
Middle Income	58623	18657	60333	20368
Sweden				
all	37360	11909	49809	24358
Middle Income	37279	11895	51829	26445
UK				
all	67261	12546	79579	24864
Middle Income	64593	11972	79948	27327
US				
all	97215	41284	87344	31412
Middle Income	94607	37358	91823	34573

90th percentile of wealth and debt

All and middle income classes

90th perc	Net worth	Fin. assets	Non-fin. assets	Debt
Canada				
all	257023	129616	152862	54225
Middle Income	240293	117387	144514	56324
Germany				
all	231781	58737	230960	72376
Middle Income	227169	55571	230960	71725
Japan				
all	184084	59187	159698	64379
Middle Income	180305	65007	164397	76573
Sweden				
all	112293	31073	119059	55907
Middle Income	106883	29476	113391	54751
UK				
all	214497	45645	207320	71051
Middle Income	208350	52559	181327	75142
US				
all	260485	114501	203852	81496
Middle Income	228686	99760	179364	77686



CROSS-NATIONAL
DATA CENTER
in Luxembourg

Median wealth and debt

All and middle income classes

Median	Net worth	Fin. assets	Non-fin. assets	Debt
Canada				
all	51237	13994	54810	10215
Middle Income	65006	21174	63491	17276
Germany				
all	52698	12063	60929	1588
Middle Income	63502	13835	79142	5466
Japan				
all	44270	9301	48079	117
Middle Income	60834	13965	64266	13616
Sweden				
all	18115	3864	35346	17008
Middle Income	21701	4470	41370	21874
UK				
all	46822	3560	70186	21698
Middle Income	131004	28985	127584	50647
US				
all	33302	4549	55048	18123
Middle Income	45315	7325	70919	27578



Gini coefficients wealth and debt

All and middle income classes

Gini coefficient	Net worth	Fin. assets	Non-fin. assets	Debt
Canada				
all	61.4	71.5	52.4	62.7
Middle Income	52.2	62.9	42.7	55.3
Germany				
all	62.4	62.7	63.0	77.1
Middle Income	57.8	57.3	58.6	73.2
Japan				
all	71.1	67.6	58.6	79.2
Middle Income	68.9	65.2	55.9	75.5
Sweden				
all	77.7	70.9	56.0	55.2
Middle Income	73.0	68.5	48.1	48.8
UK				
all	62.4	78.5	50.2	60.3
Middle Income	57.2	75.2	41.2	50.5
US				
all	71.8	81.1	59.6	62.5
Middle Income	65.0	77.2	49.4	52.7



CROSS-NATIONAL
DATA CENTER
in Luxembourg

Boxplots: example

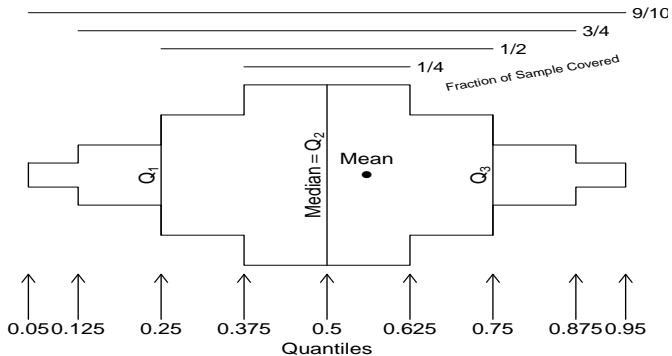

Boxplot: LWS data

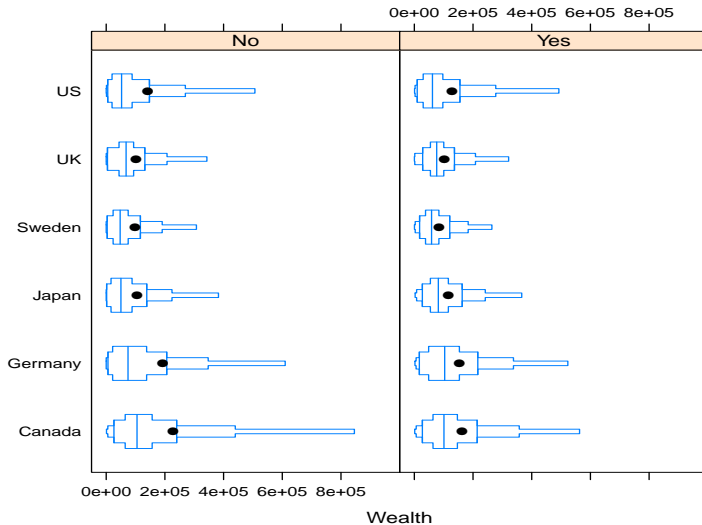

Distributions compared for wealth: Canada vs US

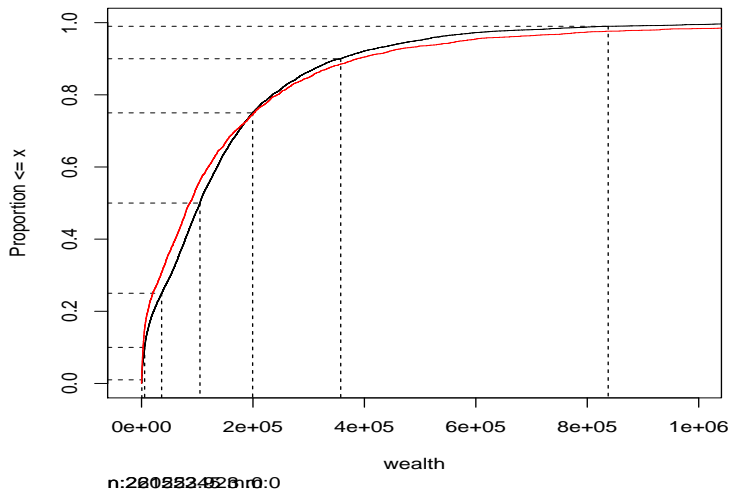

Distributions compared for income: Canada vs US

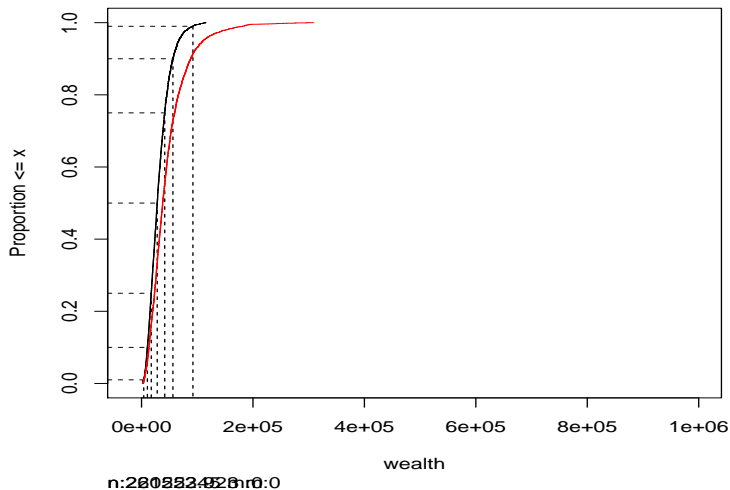

Distributions compared for wealth: Japan vs US

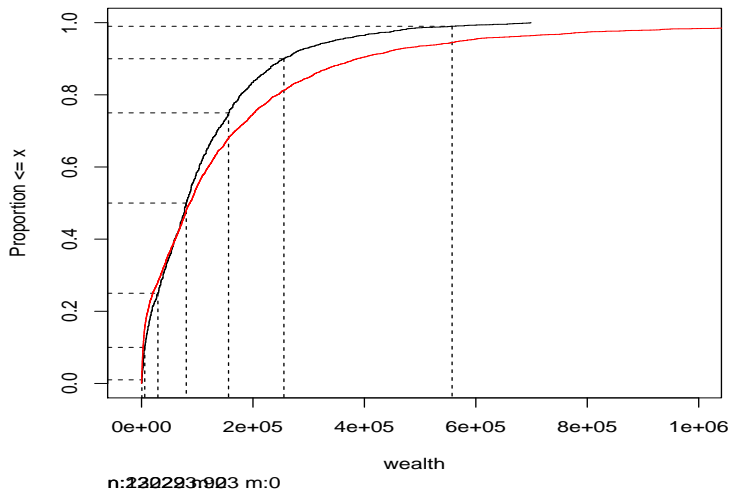

Distributions compared for income: Japan vs US

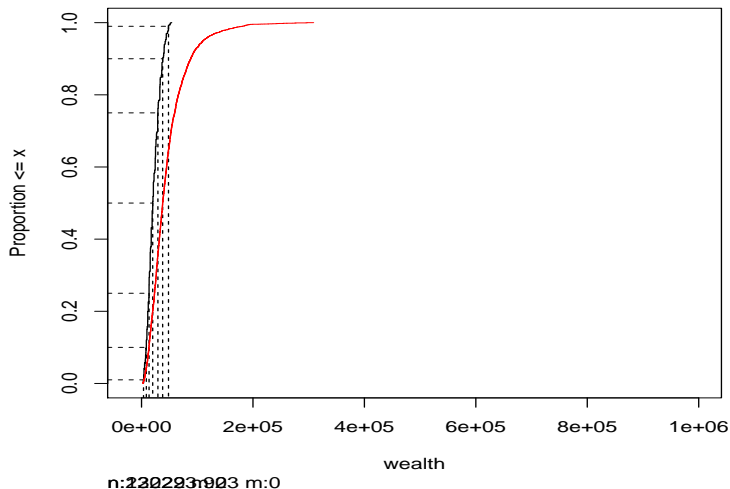

Distributions compared for wealth: Germany vs Japan

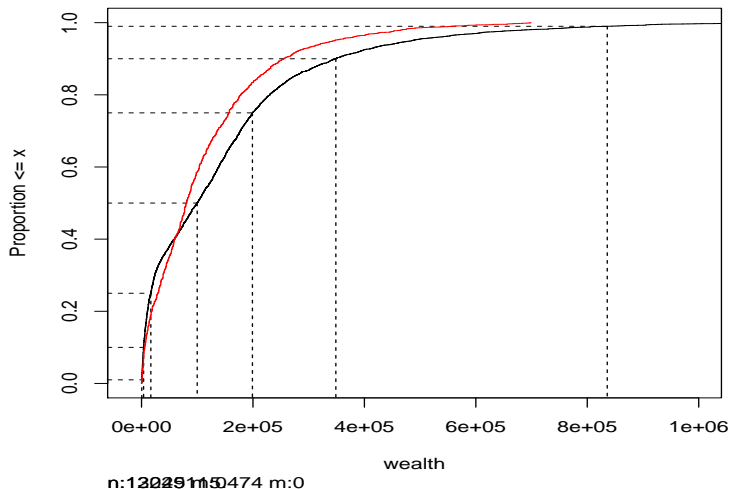

Distributions compared for income: Germany vs Japan

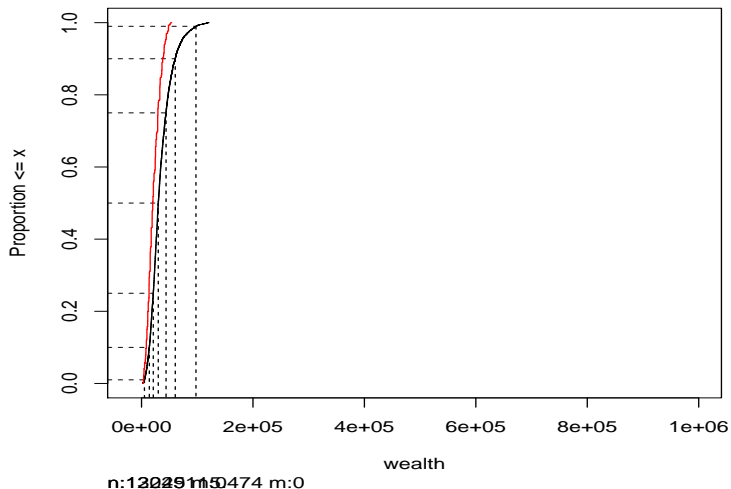

Distribution functions for wealth (unshaved data)

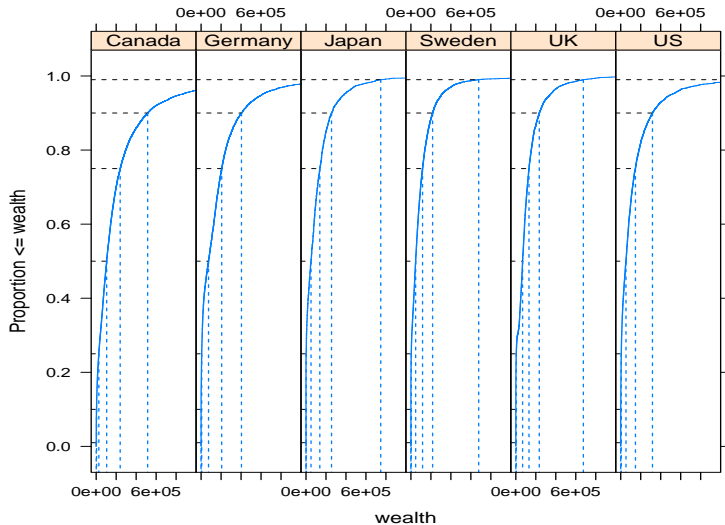

Distribution functions for income (unshaved data)

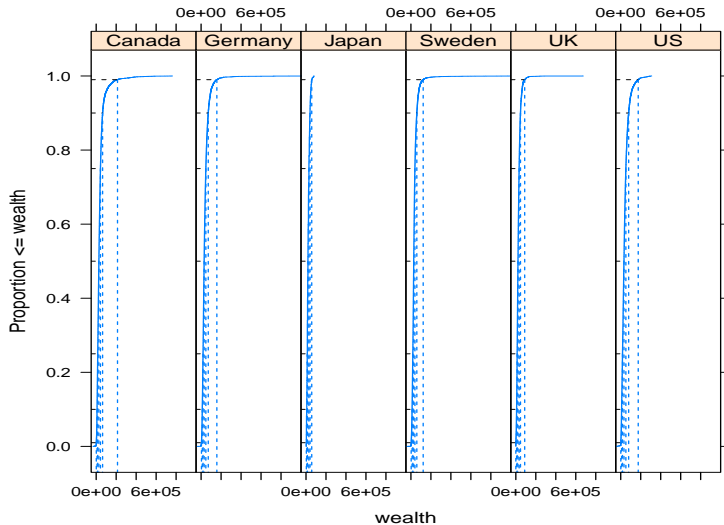

Distribution functions for wealth (shaved data)

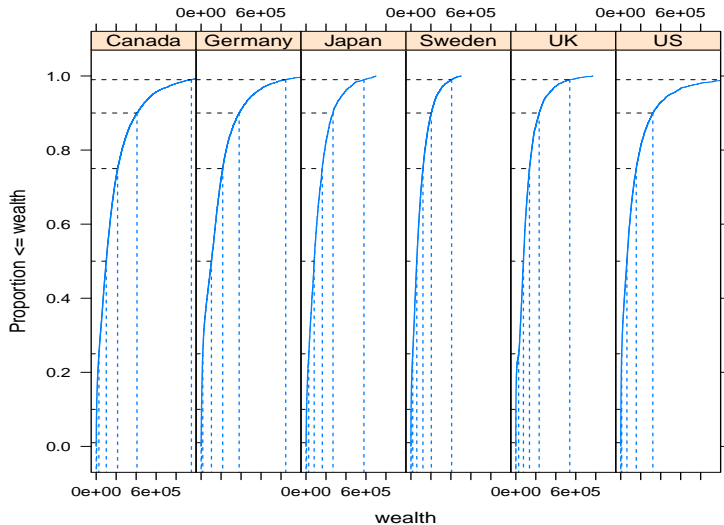

Distribution functions for income (shaved data)

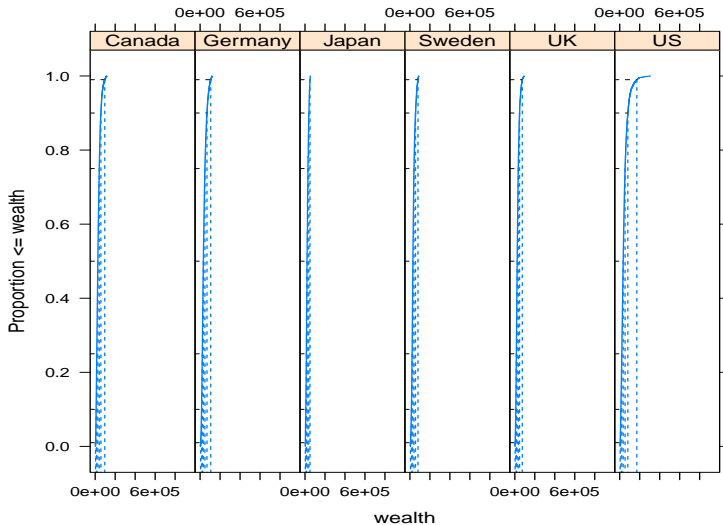

Lorenz curves for wealth: within country

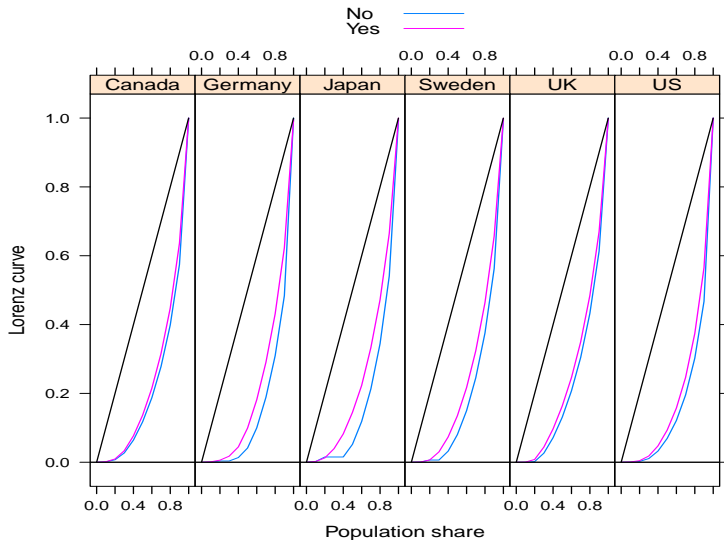

Lorenz curves for wealth: country ordering

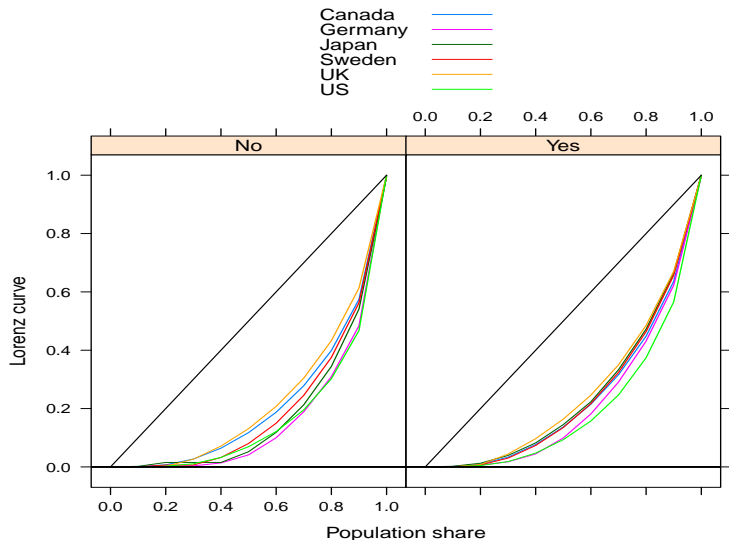

Lorenz curves for income: within country

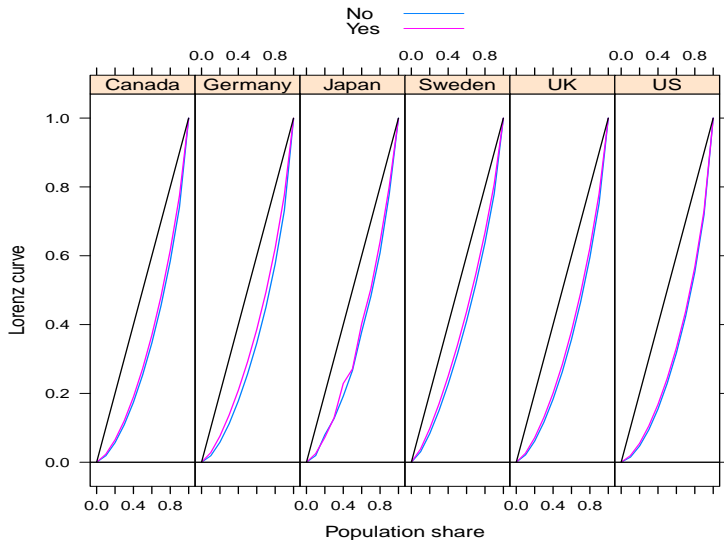

Lorenz curves for income: country ordering

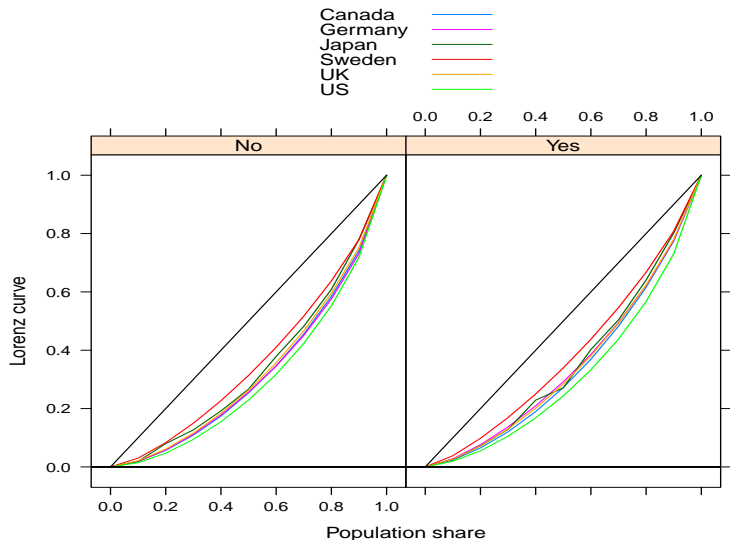

Generalized Lorenz curves for wealth: country ordering

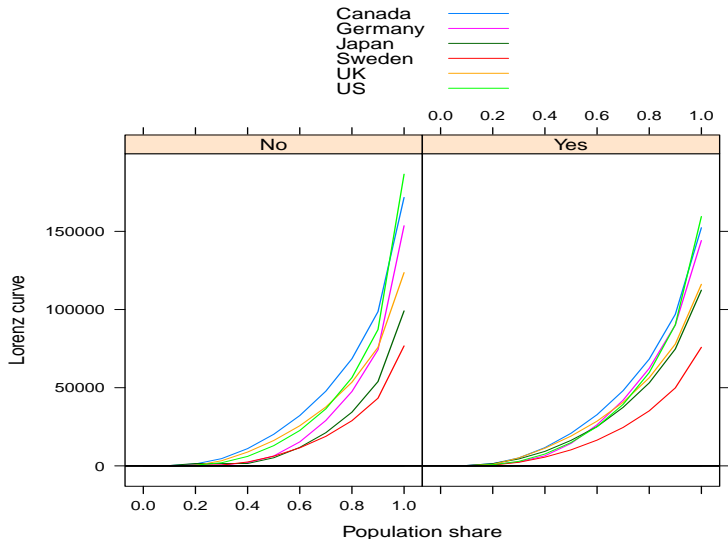

Generalized Lorenz curves for income: country ordering

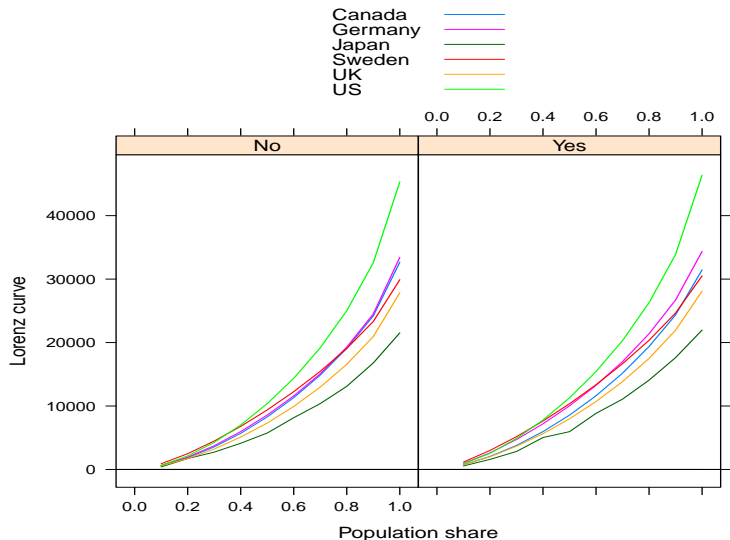

Absolute Lorenz curves for wealth: country ordering

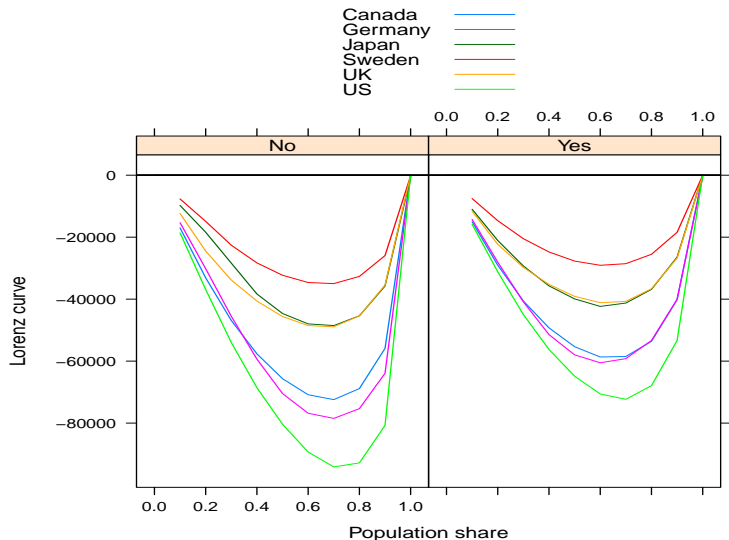

Absolute Lorenz curves for income: country ordering

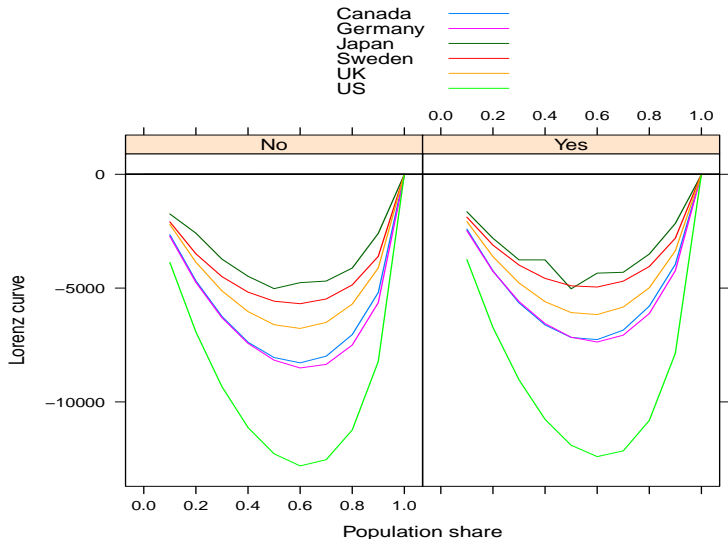

Median regressions: Gross income

Coefficient estimates and 95% CI

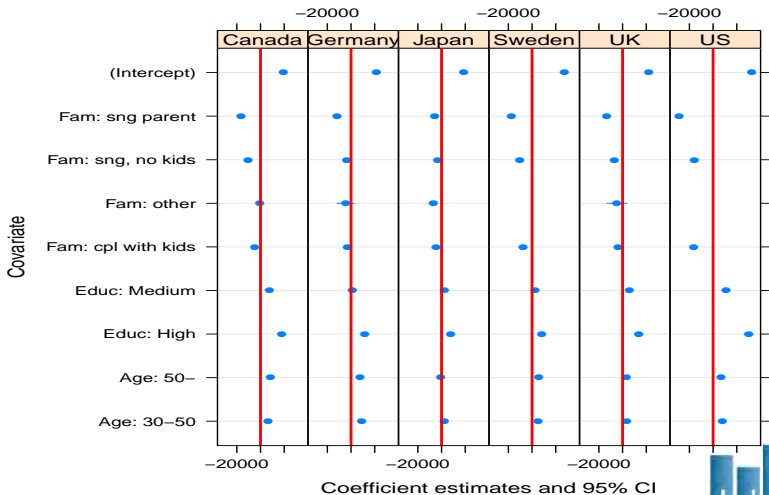

Median regressions: wealth

Coefficient estimates and 95% CI

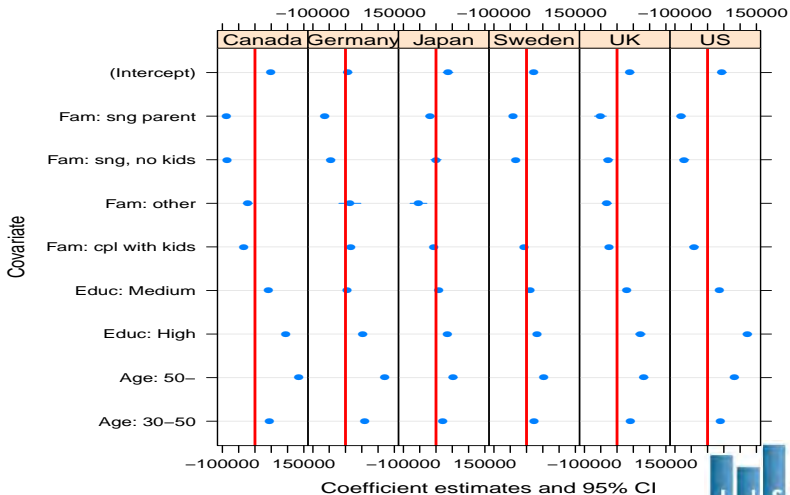

Why study the joint distribution?

- Informs us of the nature of the data.
- Wealth and income clearly related, but possibly in quite different ways.
- May reveal interesting differences that could be related to institutional and sectoral differences across countries.

Income-wealth quartile groups

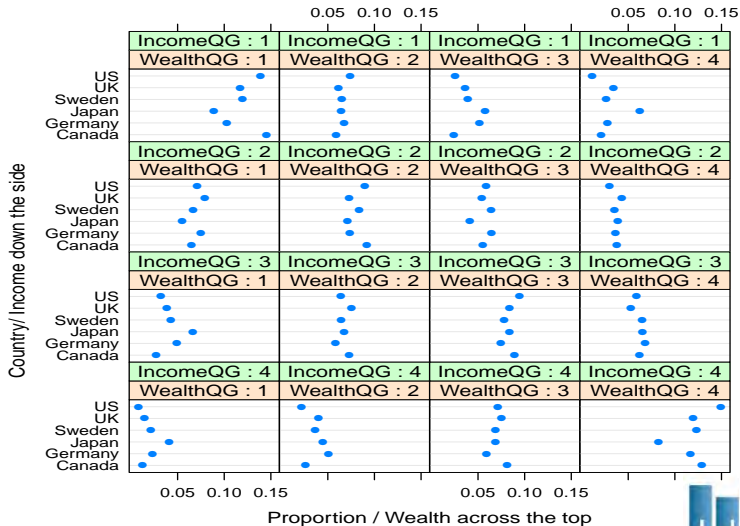

Income-wealth quartile groups

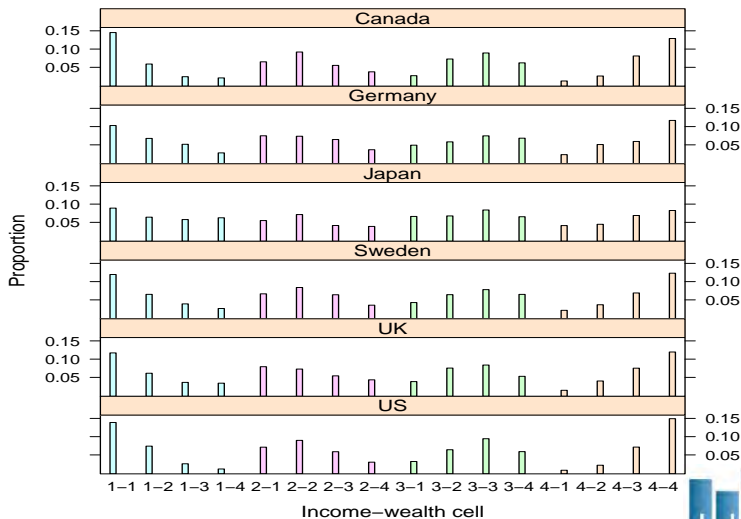

Regression results: share of variance explained

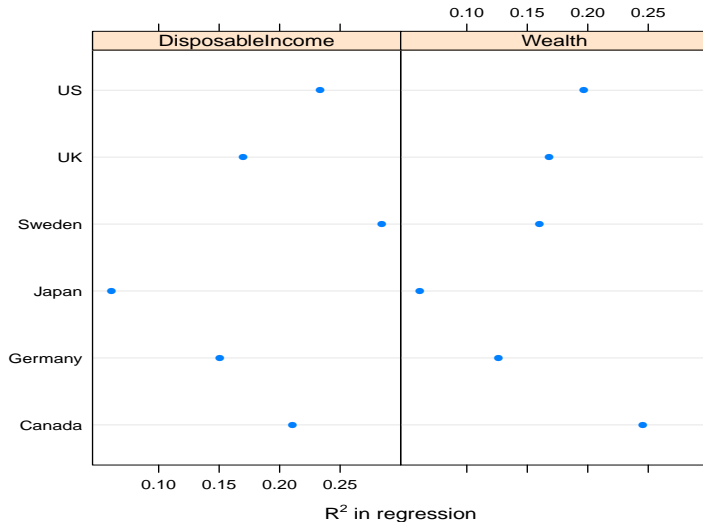

Regression results: wealth

Coefficient estimates and confidence intervals

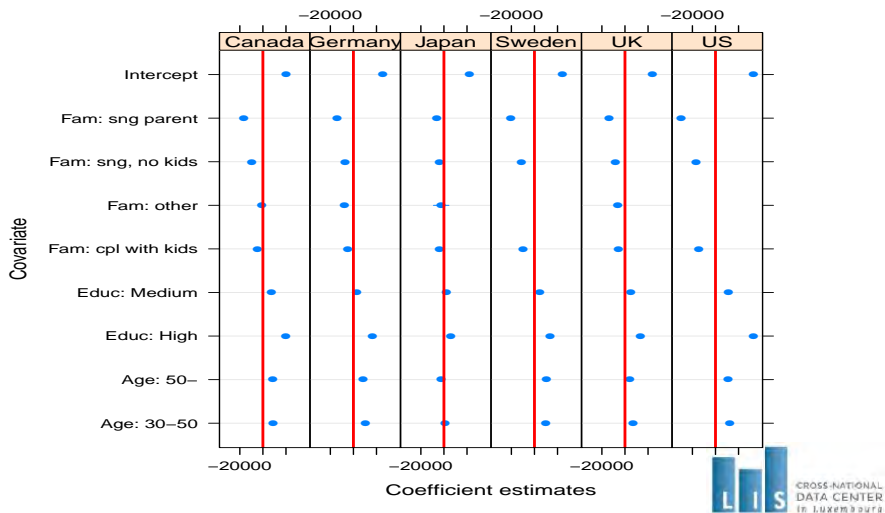

Regression results: income

Coefficient estimates and confidence intervals

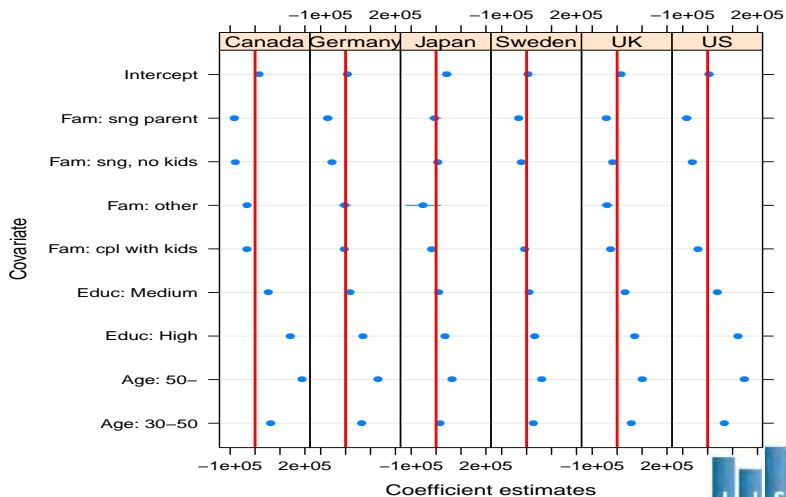

Residual standard deviation

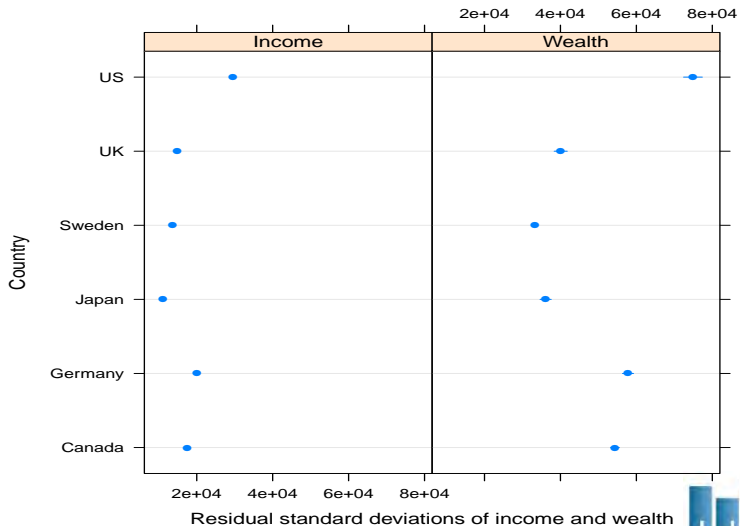

Residual correlation of gross income and wealth

